



*Nothing else measures up!*

**Follow us!**



Prospect House  
George Cayley Drive  
Clifton Moor  
York  
England  
YO30 4XE

Tel: +44 (0) 1904 692723  
Fax: +44 (0) 1904 690385

E-Mail: [sales@yorksurvey.co.uk](mailto:sales@yorksurvey.co.uk)



## Bosch GPL5 Laser Plumb



**Code: 775360**

## Operating Instructions

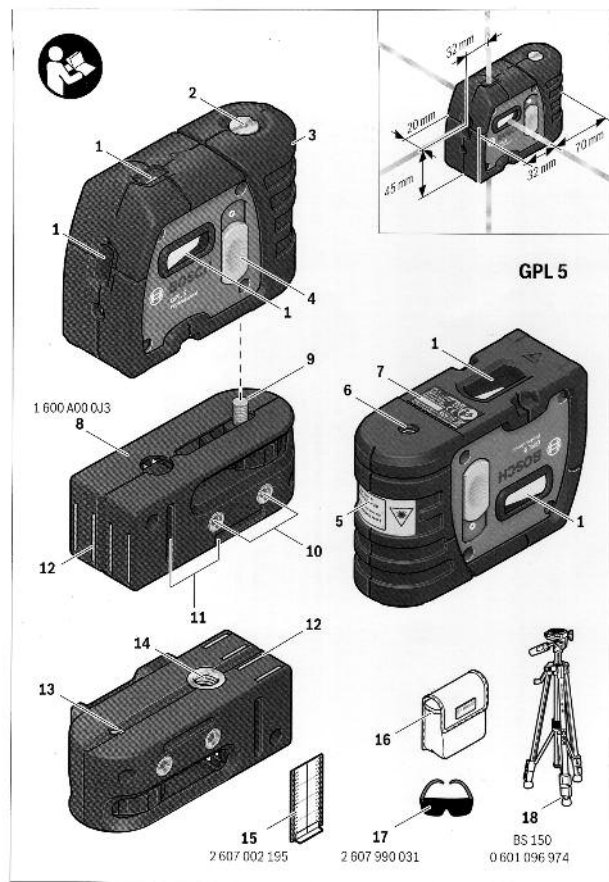

## Safety Notes

### Point Laser

**Working safely with the measuring tool is possible only when the operating and safety information are read completely and the instructions contained therein are strictly followed. Never make warning labels on the measuring tool unrecognisable. SAVE THESE INSTRUCTIONS.**

- Caution - The use of other operating or adjusting equipment or the application of other processing methods than those mentioned here, can lead to dangerous radiation exposure.
- The measuring tool is provided with a warning label in English (marked with number 5 in the representation of the measuring tool on the graphics page).



Laser Radiation Class 2  
do not stare into beam  
IEC 60825-1:2007-03  
<math>\lt; 1\text{ mW}</math>, 635 nm

- Do not direct the laser beam at persons or animals and do not stare into the laser beam yourself. This measuring tool produces laser class 2 laser radiation according to IEC 60825-1. This can lead to persons being blinded.
- Do not use the laser viewing glasses as safety goggles. The laser viewing glasses are used for improved visualisation of the laser beam, but they do not protect against laser radiation.
- Do not use the laser viewing glasses as sun glasses or in traffic. The laser viewing glasses do not afford complete UV protection and reduce colour perception.
- Have the measuring tool repaired only through qualified specialists using original spare parts. This ensures that the safety of the measuring tool is maintained.
- Do not allow children to use the laser measuring tool without supervision. They could unintentionally blind other persons or themselves.
- Do not operate the measuring tool in explosive environments, such as in the presence of flammable liquids, gases or dusts. Sparks can be created in the measuring tool which may ignite the dust or fumes.

### Holder



Keep the holder 8 away from cardiac pacemakers. The magnets 12 generate a field that can impair the function of cardiac pacemakers.

- Keep the holder 8 away from magnetic data medium and magnetically sensitive equipment. The effect of the magnets 12 can lead to irreversible data loss.

## Product Description and Specifications

Please unfold the fold-out page with the representation of the measuring tool and leave it unfolded while reading the operating instructions.

### Intended Use

The measuring tool is intended for determining and checking horizontal and vertical lines as well as plumb points.

### Product Features

The numbering of the product features shown refers to the illustration of the measuring tool on the graphic page.

- Fast opening for laser beam
- Lateral battery lid
- Battery lid
- On/Off switch
- Laser warning label
- Tripod mount 1/4"
- Serial number
- Holder
- Locking screw for holder
- Screw holes of holder
- Opening for strap attachment
- Magnets
- 1/4" tripod mount on holder
- 5/8" tripod mount on holder
- Measuring plate with stand\*
- Protective pouch
- Laser viewing glasses\*
- Tripod\*

\*The accessories illustrated or described are not included as standard delivery.

### Technical Data

Point Laser	GPL 5
Article number	3 601 K66 2
Working range	30 m
Levelling Accuracy	$\pm 0.3\text{ mm/m}$
Self-levelling range (typical) along-side the	
- longitudinal axis	$\pm 5^\circ$
- lateral axis	$\pm 3^\circ$
Levelling duration, typically	<math>\lt; 4\text{ s}</math>
Operating temperature	$-10\text{ }^\circ\text{C} \dots +40\text{ }^\circ\text{C}$
Storage temperature	$-20\text{ }^\circ\text{C} \dots +70\text{ }^\circ\text{C}$
Relative air humidity, max.	90 %
Laser class	2

Laser type	635 nm, <math>\lt; 1\text{ mW}</math>
Tripod mount	1/4"
Batteries	3 x 1.5 V LR06 (AA)
Operating life time, approx.	24 h
Weight according to EN 61331-1:2003	0.25 kg
Dimensions (length x width x height)	104 x 40 x 80 mm
Degree of protection	IP 5X

## Assembly

### Inserting/Replacing the Battery

Alkaline manganese batteries are recommended for the measuring tool.

To open the battery compartment 3, turn the latch 2 in clockwise direction to position 0 and pull off the battery lid, insert the batteries provided. When inserting, pay attention to the correct polarity according to the representation on the inside of the battery compartment.

Position the battery lid to the bottom of the housing and then push it upward. To lock the battery lid, turn the latch 2 in anticlockwise direction to the 0 position.

When the laser beams flash slowly during operation, the batteries are low. When the flashing begins, the measuring tool can be operated for approx. 6 h. Always replace all batteries at the same time. Only use batteries from one brand and with the identical capacity.

- Remove the batteries from the measuring tool when not using it for extended periods. When storing for extended periods, the batteries can corrode and discharge themselves.

## Operation

### Initial Operation

- Protect the measuring tool against moisture and direct sun light.
- Do not subject the measuring tool to extreme temperatures or variations in temperature. As an example, do not leave it in vehicles for long time. In case of large variations in temperature, allow the measuring tool to adjust to the ambient temperature before putting it into operation. In case of extreme temperatures or variations in temperature, the accuracy of the measuring tool can be impaired.
- Avoid heavy impact or falling of the measuring tool. After heavy exterior impact on the measuring tool, an accuracy check should always be carried out before continuing to work (see "Levelling Accuracy").
- Switch the measuring tool off during transport. When switching off, the levelling unit is locked.

### Switching On and Off

To switch on the measuring tool, push the On/Off switch 4 upward so that "I" is indicated on the switch. Immediately after switching on, the measuring tool sends a laser beam out of each wall opening 1.

- Do not point the laser beam at persons or animals and do not look into the laser beam yourself, not even from a large distance.

To switch off the measuring tool, push the On/Off switch 4 downward so that "0" is indicated on the switch. When switching off, the levelling unit is locked.

### Setting the Automatic Switch-Off

By default, the measuring tool automatically shuts off 20 minutes after being switched on.

The automatic switch-off can be set from 20 minutes to 8 hours. To do this, switch the measuring tool on, then immediately off, and then on again within 4 s. To confirm the change, all laser beams will flash quickly for 2 s after switching on the second time.

- Do not leave the switch on measuring tool unattended and switch the measuring tool off after use. Other persons could be blinded by the laser beam.

When switching on the measuring tool the next time, the automatic switch-off is set to 20 minutes again.

### Working with Automatic Levelling

Position the measuring tool on a level and firm support, attach it to the holder 8 or to the tripod 18.

After switching on, the automatic levelling function automatically compensates irregularities within the self-levelling range from  $\pm 5^\circ$  (longitudinal axis) and  $\pm 3^\circ$  (lateral axis). The levelling is finished as soon as the laser points do not move any more.

If the automatic levelling function is not possible, e.g. because the surface on which the measuring tool stands deviates by more than  $5^\circ$  or  $3^\circ$  from the horizontal plane, the laser beams flash rapidly. In this case, bring the measuring tool to the level position and wait for the self-levelling to take place. As soon as the measuring tool is within the self-levelling range of  $\pm 5^\circ$  or  $\pm 3^\circ$  respectively, all laser beams light up continuously again.

In case of ground vibrations or position changes during operation, the measuring tool is automatically levelled in again. To avoid errors by moving the measuring tool, check the position of the laser beams with regard to the reference points upon re-levelling.

### Levelling Accuracy

The ambient temperature has the greatest influence. Especially temperature differences occurring from the ground upward can divert the laser beam.

As thermal fluctuation is largest close to the ground, the measuring tool, if possible, should be mounted on a commercially available tripod and placed in the centre of the working area.

Apart from exterior influences, device-specific influences (such as heavy impact or falling down) can lead to deviations. Therefore, check the accuracy of the measuring tool each time before starting your work.

Should the measuring tool exceed the maximum deviation on during one of the tests, please have it repaired by a Bosch after-sales service.

When the levelling accuracy of the horizontal laser beams for the lateral and longitudinal axis is within the maximum allowable deviation, then the levelling accuracy for the plumb beams (vertical axis) is thus also checked.

### Checking the Horizontal Levelling Accuracy of the Lateral Axis

A firm measuring distance of 20 m on a firm surface in front of a wall is required for the check.

- Mount the measuring tool onto the holder 8 or tripod, or place it on a firm and level surface at a distance of 20 m to the wall.

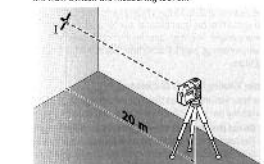

- Direct one of the two lateral laser beams, that run along side the lateral axis of the measuring tool, at the wall. Adjust the measuring tool to level in. Mark the centre of the laser beam on the wall (point I).

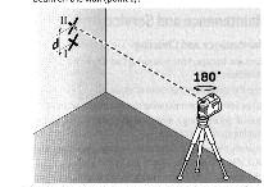

- Rotate the measuring tool by approx.  $180^\circ$  without changing its height. Allow it to level in and mark the centre point of the other lateral laser beam on the wall (point II). Take care that point II is as vertical as possible above or below point I.

The difference  $d$  of both marked points I and II on the wall results in the actual height deviation of the measuring tool along the lateral axis.

On the measuring distance of  $2 \times 20\text{ m} = 40\text{ m}$ , the maximum allowable deviation is:

$$40\text{ m} \times 0.3\text{ mm/m} = \pm 12\text{ mm}$$

Thus, the difference  $d$  between points I and II may not exceed  $\pm 2\text{ mm}$  (max.).

### Checking the Horizontal Levelling Accuracy of the Longitudinal Axis

A firm measuring distance of 20 m on a firm surface between two walls and 3 is required for the check.

Mount the measuring tool into the holder 8 or tripod, or place it on a firm and level surface close to wall A. Switch the measuring tool on.

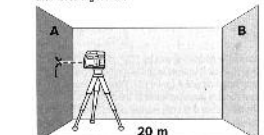

- Direct the horizontal laser beam, which runs parallel to the longitudinal axis of the measuring tool, at the close wall A. Allow the measuring tool to level in. Mark the centre of the laser beam on the wall (point I).

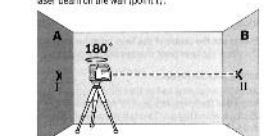

- Turn the measuring tool around by  $180^\circ$ , allow it to level in and mark the centre point of the laser beam on the opposite wall (point II).
- Without turning the measuring tool, position it close to wall B. Switch the measuring tool on and allow it to level in.

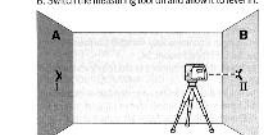

- Align the height of the measuring tool (using the tripod or by underlaying, if required) in such a manner that the centre point of the laser beam is projected exactly against the previously marked point II on wall 3.

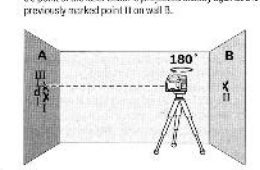

- Rotate the measuring tool by  $180^\circ$  without changing its height. Allow it to level in and mark the centre point of the laser beam on wall A (point II). Take care that point II is as vertical as possible above or below point I.

The difference  $d$  of both marked points I and II on wall A results in the actual height deviation of the measuring tool along the longitudinal axis.

On the measuring distance of  $2 \times 20\text{ m} = 40\text{ m}$ , the maximum allowable deviation is:

$$40\text{ m} \times 0.3\text{ mm/m} = \pm 12\text{ mm}$$

Thus, the difference  $d$  between points I and II may not exceed  $\pm 2\text{ mm}$  (max.).

### Working Advice

- Always use the centre of the laser point for marking. The size of the laser point changes with the distance.

### Attaching to the Holder

To fasten the measuring tool on the holder 8, screw the locking screw 9 of the holder into the 1/4" tripod mount 6 on the measuring tool and tighten. To rotate the measuring tool on the holder, slightly loosen the screw 9.

- Rotate the measuring tool on the holder 8 sideward or toward the rear to make the bottom plants beam visible. Rotate the measuring tool on the holder 8 to project heights with the horizontal laser beam.

With the holder 8, the measuring tool can be attached as follows:

- Mount the holder 8 to the tripod 18 or a commercially available camera tripod via the 1/4" tripod mount 6. For fastening to a commercially available construction tripod, use the 5/8" tripod mount 14.
- The holder 8 can be fastened to steel parts via the magnets 12.
- The holder 8 can be fastened to drywalls or wood walls with screws. For this, insert screws with a minimum length of 60 mm into the screw holes 10 of the holder.
- The holder 8 can also be fastened to pipes or similar beams using a commercially available strap by threading it through the opening 11 for strap attachment.

### Working with the Tripod (Accessory)

A tripod 18 offers a stable, height-adjustable measuring support. Place the measuring tool via the tripod mount 6 onto the 1/4" male thread of the tripod and screw the locking screw of the tripod tight.

### Working with the Measuring Plate (Accessory)

With the measuring plate 15, it is possible to project the laser mark onto the floor or the laser height onto a wall.

With the zero scale and the scale, the offset or drop to the required height can be measured and projected onto the location. This eliminates the necessity of precisely adjusting the measuring tool to the height to be projected.

The measuring plate 15 has a reflective coating that enhances the visibility of the laser beam at greater distances or in intense sunlight. The bright lines are reflected into and seen only when viewing, parallel to the laser beam, into the measuring plate.

### Laser Viewing Glasses (Accessory)

The laser viewing glasses filter out the ambient light. This makes the red light of the laser appear brighter for the eyes.

- Do not use the laser viewing glasses as safety goggles. The laser viewing glasses are used for improved visualisation of the laser beam, but they do not protect against laser radiation.

Do not use the laser viewing glasses as sun glasses or in traffic. The laser viewing glasses do not afford complete UV protection and reduce colour perception.

## Maintenance and Service

### Maintenance and Cleaning

Store and transport the measuring tool only in the supplied protective pouch.

Keep the measuring tool clean at all times.

Do not immerse the measuring tool in water or other liquids. Wipe off debris using a moist and soft cloth. Do not use any cleaning agents or solvents.

Regularly clean the surfaces at the slit opening of the laser in particular, and stay attention to any fluff of fibres.

If the measuring tool should fail despite the care taken in manufacturing and testing procedures, repair should be carried out by an authorisation after sales service centre for Bosch power tools. Do not open the measuring tool yourself.

In all correspondence and spare parts orders, please always include the 10-digit article number given on the type plate of the measuring tool.

In case of repairs, send in the measuring tool packed in its protective pouch 16.