

7. Notes

- (1) This meter has already been calibrated before delivery.
- (2) Repairs or servicing should only be performed by York Survey Supply Centre.
- (3) Remove the battery when the meter is to be stored for long periods of time to avoid battery leakage.

8. Accessories

- ◆ User manual
- ◆ 9V battery
- ◆ Tripod (Optional)

YORK Survey Supply

Velocity Volume Thermo-Anemometer



Operating Instructions

YORK
Survey Supply

Prospect House, George Cayley Drive, Clifton Moor, York, England YO30 4XE

Tel: +44 (0) 1904 692723 Fax: +44 (0) 1904 690385
E-Mail: sales@yorksurvey.co.uk www.yorksurvey.co.uk

Follow us!

 York Survey Supply Centre
 @York_Survey
 @York_Survey

1. Safety

Read the following safety information carefully before attempting to operate the meter.

Use the meter only as specified in this manual; otherwise, the warranty may be invalidated.

◆ Environment conditions:

RH≤90% (Non-Condensation)

Operating Temperature: -10°C ~ 60°C

◆ Maintenance

Repairs or servicing should only be performed by ATP Instrumentation Ltd.

Cleaning: Wipe the unit with a dry soft cloth. Do not use abrasives or solvents on this instrument.

◆ Safety Symbol

 Complies with EMC

2. Introduction

The Anemometer is designed for measuring air velocity, air flow and temperature. 55mm high contrast easy-read backlit LCD display with function indicators for air velocity, temperature and air velocity level, shown at the same time.

3. Specifications

Circuit	based on fast and high accurate MCU design
Display	55mm Hi-Contrast LCD with Backlight
Sampling time	1 time per second
Temperature measuring	High accuracy NTC resistance
Temperature range	-30°C ~ -60°C / -22°F ~ -140°F
Temperature accuracy	±1.5°C / ±2.7°F
Air velocity range	0.3m/s ~ 45m/s
Operation Temperature	-10°C ~ -60°C / 14°F ~ 140°F
Operating Humidity	≤90%RH (Non-condensation)
Storage Temperature	-10°C ~ -60°C / 14°F ~ 140°F
Air velocity level indication	level 1-12 by analog bar-graph, level 12 above by digits
Measurement average	30 points average for air flow
Maximum / Minimum	MAX/MIN
Reading freezing	Hold
Area set	0.001 ~ 9999 m ² (0.001 ~ 9999ft ²)
Power Supply	1x 9V battery with type of 006P, NEDA1604 or IEC6F22
Auto power off	Automatically power off after approx. 15 minutes of inactivity
Resolution	m/s:0.01, km/h:0.1, ft/min:1, knots:0.1 mph:0.1, cmm:0.001, cfm:0.001
Dimension(L*W*H)	185 x 66 x 33mm
Weight	311g

4. Meter Description

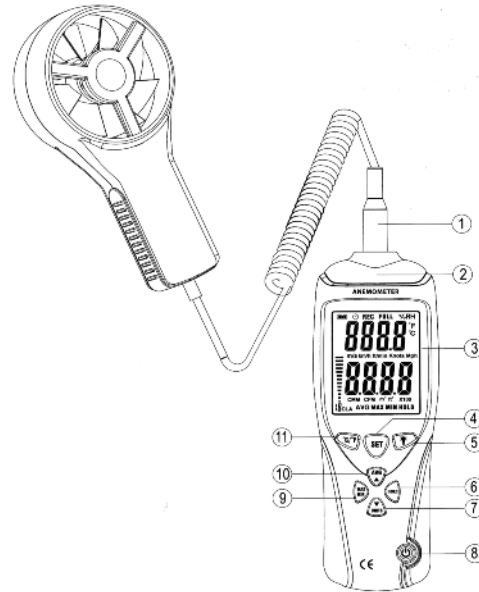

- ① Air Velocity Sensor
- ② Sensor Interface
- ③ LCD Display
- ④ SET Button
- ⑤ Backlight Button
- ⑥ HOLD Button
- ⑦ Velocity Units Selection/DOWN
- ⑧ Power ON/OFF
- ⑨ MAX/MIN
- ⑩ AVG/UP
- ⑪ Temperature Units
- ⑫ Battery Cover
- ⑬ ¼" Tripod Bush

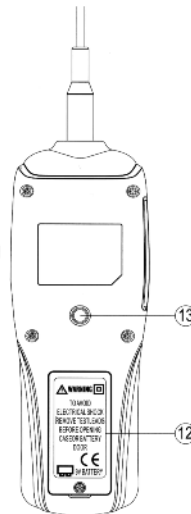

5. LCD Display Description

- ① Battery Power Indication
- ② Auto Power OFF icon
- ③ Measuring temperature readings
- ④ Temperature units
- ⑤ Air Velocity Units:
 - m/s, km/h, ft/min,
 - knots (nautical miles per hour),
 - MPH
- ⑥ Air Velocity readings
- ⑦ Air flow & Area units
 - Air flow: CMM (cubic meter per minute), CFM (cubic feet per minute) × 100 (Displayed data × 100);
 - Area: m², ft²
- ⑧ HOLD Icon
- ⑨ MAX/MIN Icon
- ⑩ AVG Icon
- ⑪ Air Velocity level indication
- ⑫ Analog bar-graph indication for air velocity level

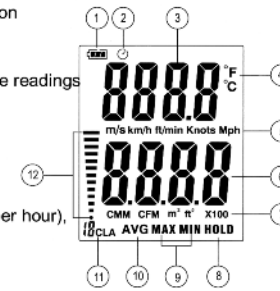



6. Operating Instructions

(1) Open battery cover and install a 9-volt battery in the battery compartment.

(2) Power ON: To turn the meter on, press the  button for 1 second until the LCD is lit, then release the button.

(3) Power OFF: To turn the meter off, press and hold the  button for approx. 3 seconds until the LCD is switched off, then release the button.

(4) Backlight: After turning the meter on, momentarily press  button, the backlight will turn on/off. It will automatically turn off after approx. 30 seconds of inactivity.

(5) Units selection: After enter measuring mode, press  button to select desired units.



(6) HOLD: Press  button one time, "HOLD" icon will appear on LCD, which indicates the reading is frozen. Press the button again to exit HOLD mode.

(7) MAX/MIN: Press  button one time until "MAX" icon appears on the LCD to view the current MAX reading; press the button again, "MIN" icon will appear to view the current

MIN reading. To exit the MAX/MIN mode, press the  button again.

(8) AVG Button: Press  button one time, 'AVG' will appear on LCD and the meter will enter the average measuring mode. The average reading of the latest 30 records will be displayed on the LCD.

(9) Temperature Units selection: Press  button to select °C or °F.

(10) Area Units Set: Press  button and then power the meter on, release  button when LCD displays, at the time the display will show as following (**Note:** the area units can be set by  button):



Set the area units as square meter (fig. as above)



If the set area is above 9999 square meters, the actual area = displayed data × 100



Set the area units as square feet (fig. as above)



If the set area is above 9999 square feet, the actual area = displayed data × 100